

TECHNICAL DRAWING / DESSIN TECHNIQUE

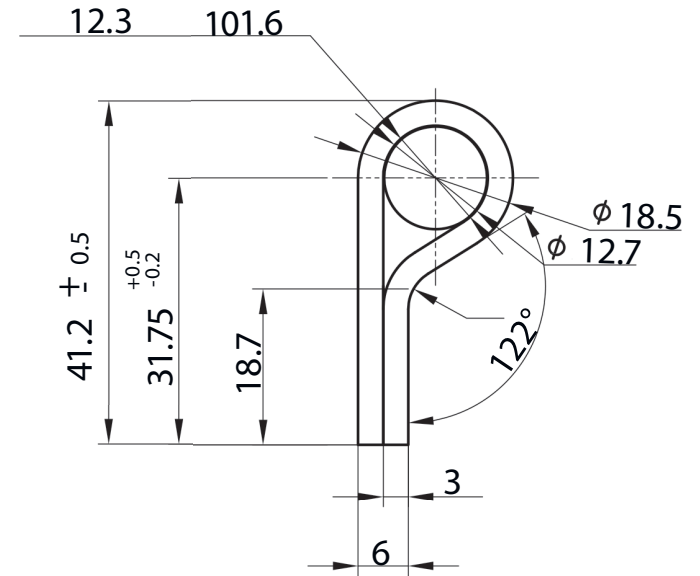
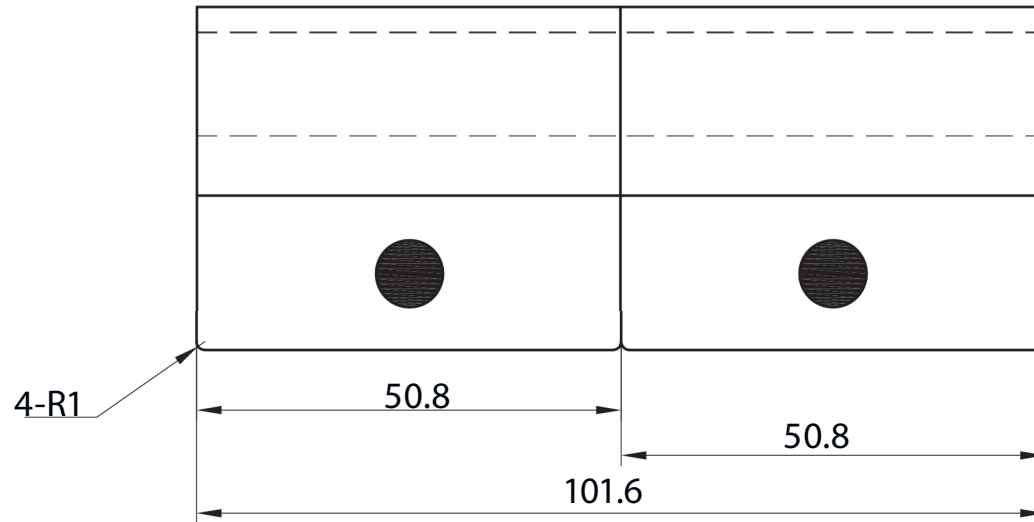

JIMEXS
HARDWARE

1 866 447-5656 / INFO@JIMEXS.COM

WWW.JIMEXS-HARDWARE.COM

203-271

Hinge
Penture

2022-01-06

PROJECTIONS

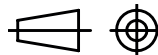

DIMENSIONS 0,50" x 4,50"
MATERIAL / MATÉRIEL Plein Steel / Acier nu