

TECHNICAL DRAWING / DESSIN TECHNIQUE

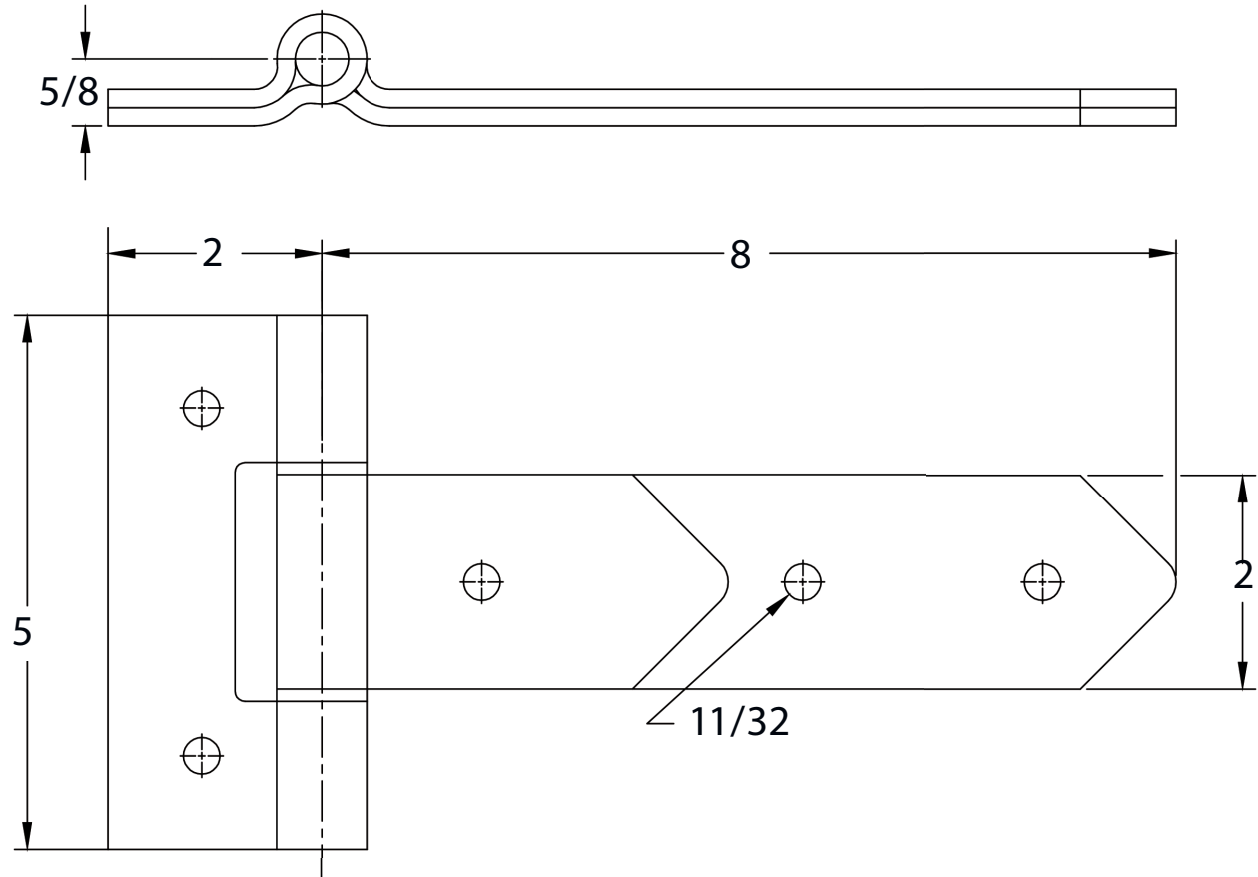

JIMEXS
HARDWARE

1 866 447-5656 / INFO@JIMEXS.COM

WWW.JIMEXS-HARDWARE.COM

204-008

Strap hinge
Penture à lame

2022-01-06

PROJECTIONS

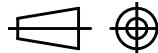

DIMENSIONS 8"X 2"

MATERIAL / MATÉRIEL Zinc plated steel / Acier plaqué Zinc