

TECHNICAL DRAWING / DESSIN TECHNIQUE

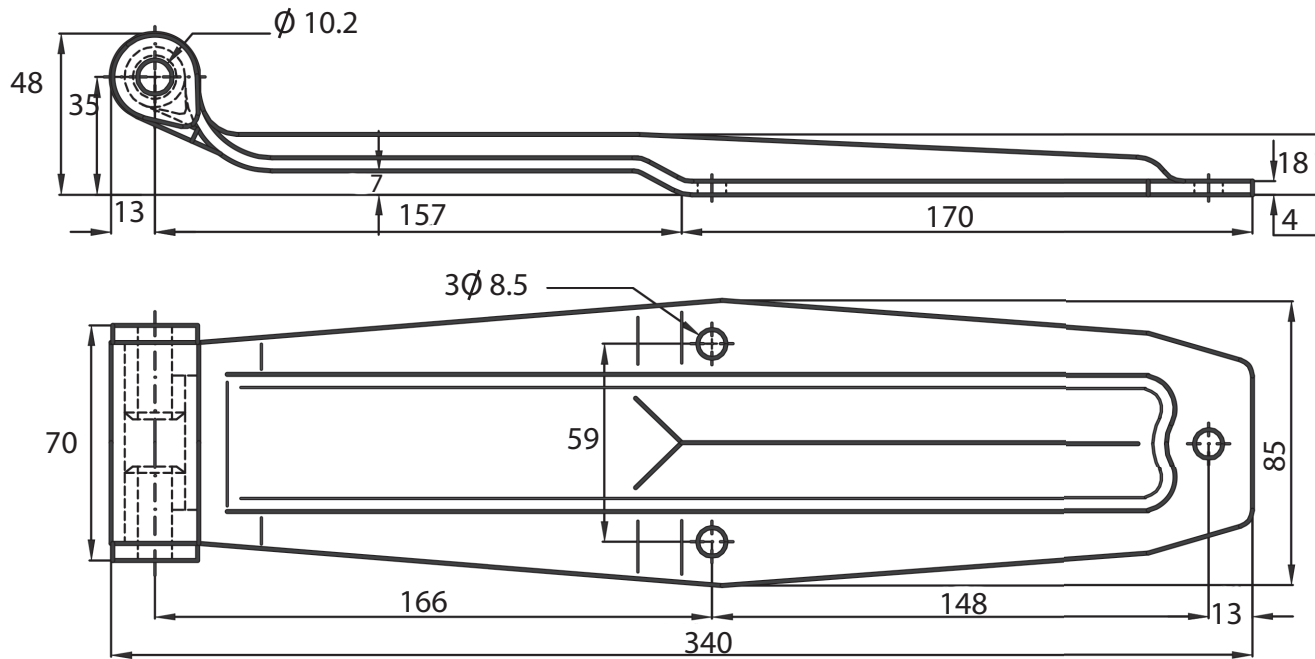

JIMEXS
HARDWARE

1 866 447-5656 / INFO@JIMEXS.COM

WWW.JIMEXS-HARDWARE.COM

204-875

Strap hinge
 Penture à lame

2021-04-20

PROJECTIONS



DIMENSIONS

MATERIAL / MATÉRIEL

12,87" x 3,35" / 327mm x 85mm

Polished Stainless Steel (304) /

Acier Inoxydable Poli (304)