

TECHNICAL DRAWING / DESSIN TECHNIQUE

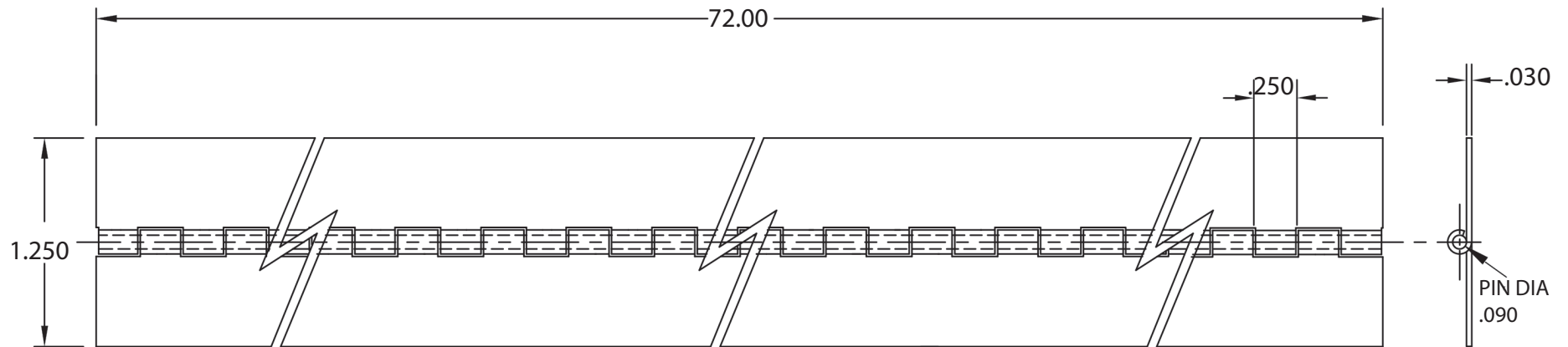

JIMEXS
HARDWARE

1 866 447-5656 / INFO@JIMEXS.CO M
WWW.HARDWARE.COM

210-103

Piano hinge
Penture piano

2021-09-21

PROJECTIONS

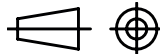

DIMENSIONS

72"x 1-1/4" Open / Ouvert
0,030" Thickness / Epaisseur
0,090" pin diam. / Diam.de tige
1/4" knuckle / Articulation

MATERIAL/MATÉRIEL Plain Steel / Acier brut