

TECHNICAL DRAWING / DESSIN TECHNIQUE

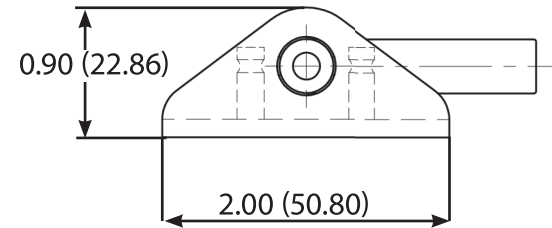
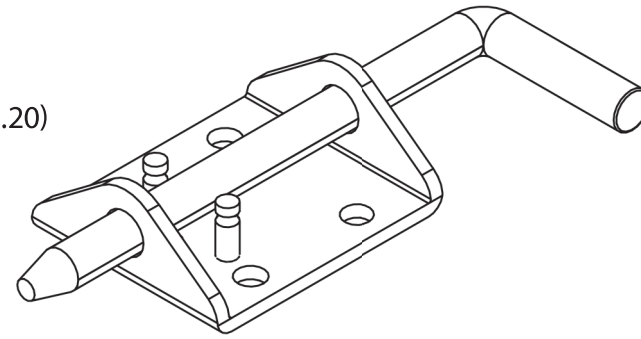
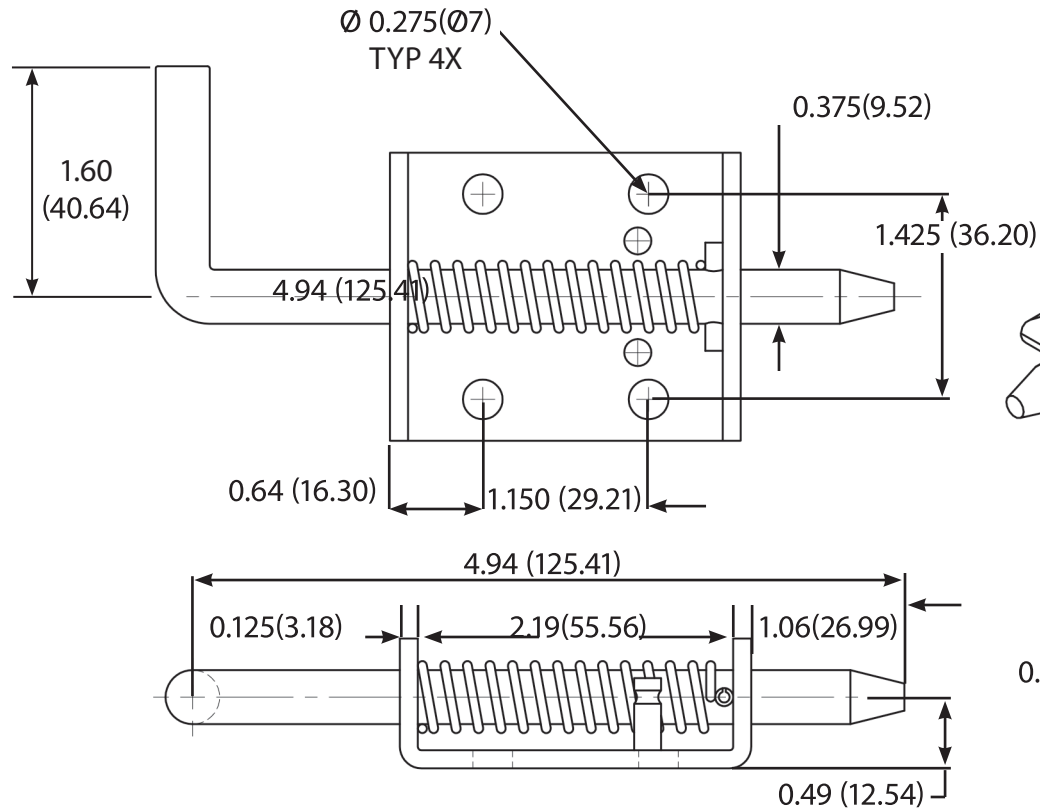

JIMEXS
HARDWARE

1 866 447-5656 / INFO@JIMEXS.COM

WWW.JIMEXS-HARDWARE.COM

240-151

Spring latch bolt
Verrou à ressort

2021-07-05

PROJECTIONS

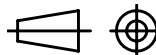

MATERIAL/MATÉRIEL

Steel zinc plated /
Acier plaqué zinc