

TECHNICAL DRAWING / DESSIN TECHNIQUE

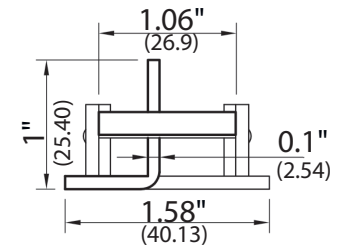
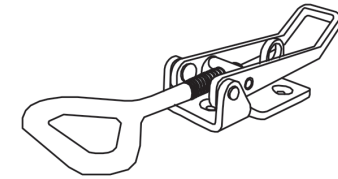
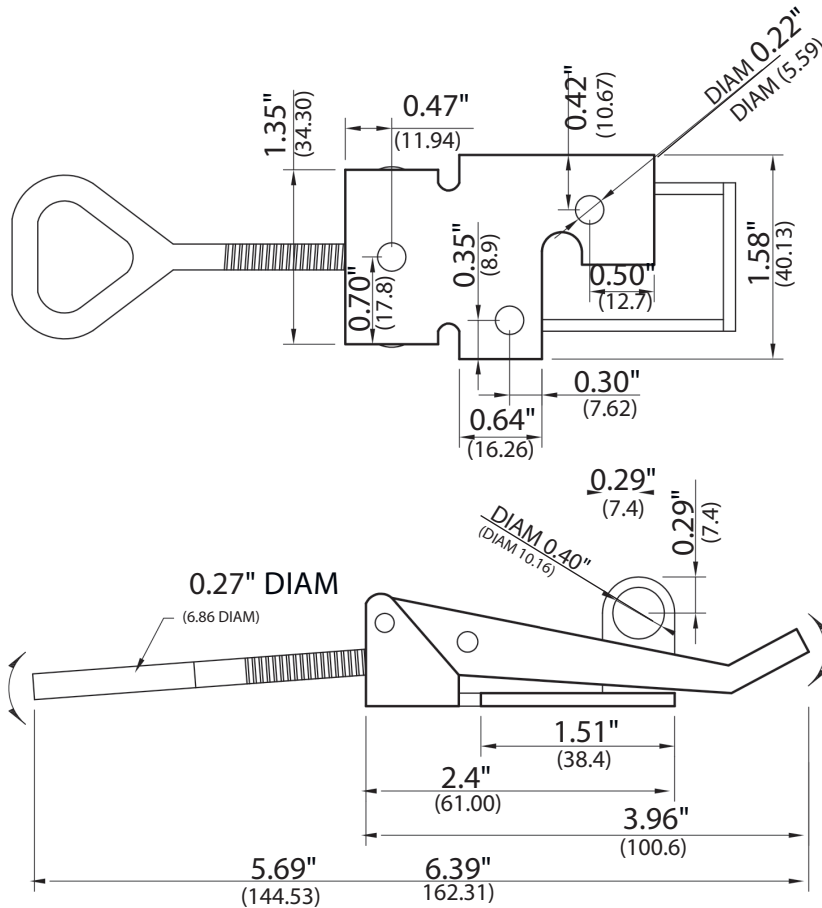

JIMEXS
HARDWARE

1 866 447-5656 / INFO@JIMEXS.COM

WWW.JIMEXS-HARDWARE.COM

243-176

Adjustable latch
Attache ajustable

2022-01-06

PROJECTIONS

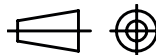

DIMENSIONS

MATERIAL/MATÉRIEL

SPECIFICATIONS / SPÉCIFICATIONS

6,4"

Stainless steel (304) /
Acier inoxydable (304)

Locking / Verrouillable