

TECHNICAL DRAWING / DESSIN TECHNIQUE

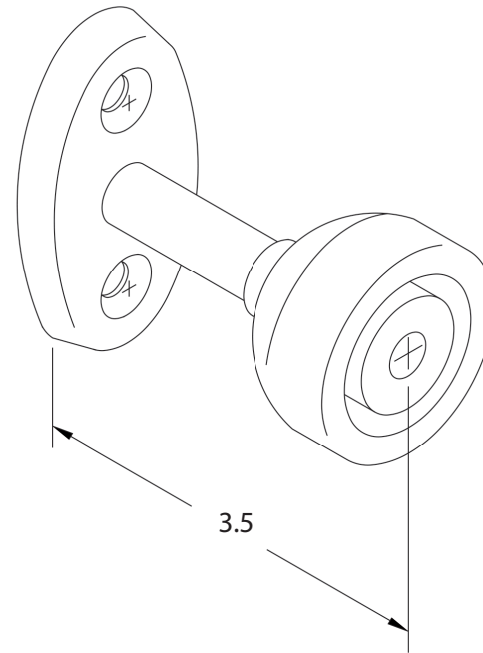
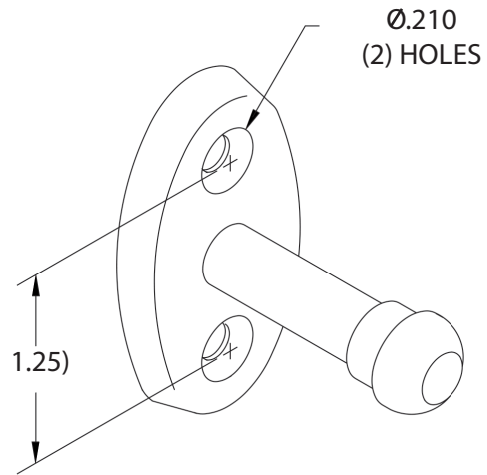

JIMEXS
HARDWARE

1 866 447-5656 / INFO@JIMEXS.COM

WWW.JIMEXS-HARDWARE.COM

251-221

Door holder
Arrêt de porte

2022-01-06

PROJECTIONS

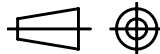

DIMENSIONS
MATERIAL/MATÉRIEL

3" L - 1,25" CC (kit = 3,5")
Steel zinc plated
Acier plaqué zinc