

# TECHNICAL DRAWING / DESSIN TECHNIQUE

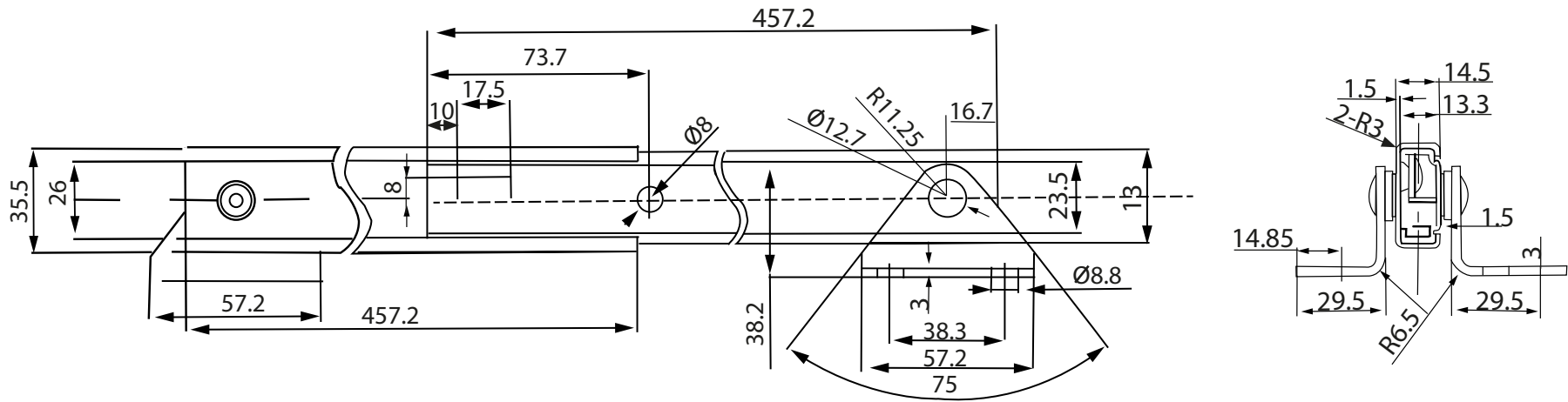

**JIMEXS**  
**HARDWARE**

1 866 447-5656 / INFO@JIMEXS.COM

WWW.JIMEXS-HARDWARE.COM

261-118

Telescopic prop  
 Support télescopique

2022-01-06

PROJECTIONS

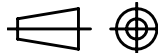

DIMENSIONS

MATERIAL/MATÉRIEL

18"

Steel Zinc plated

Acier plaqué Zinc