

TECHNICAL DRAWING / DESSIN TECHNIQUE

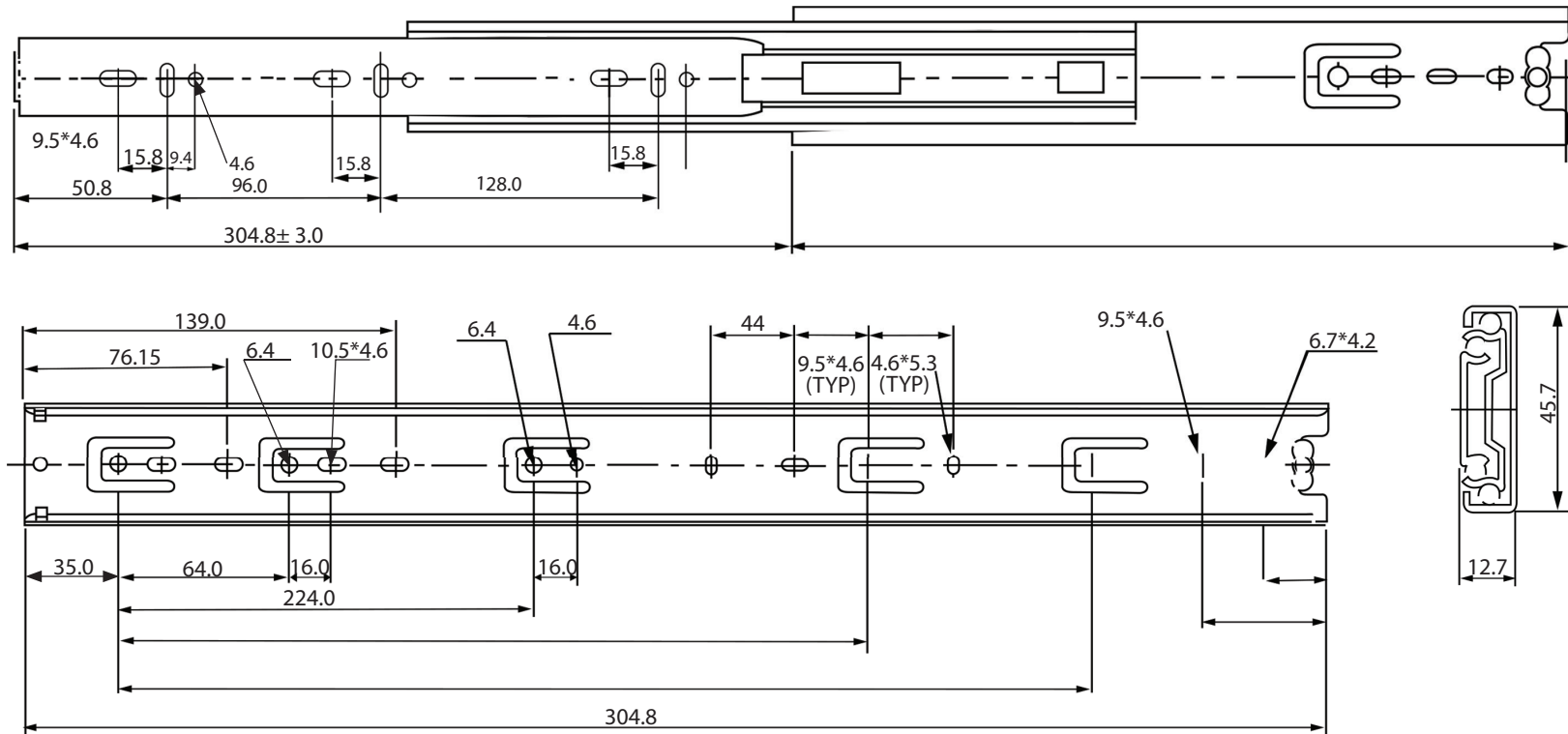

JIMEXS
HARDWARE

1 866 447-5656 / INFO@JIMEXS.COM

WWW.JIMEXS-HARDWARE.COM

323-112

Drawer Slides - Cap. 100 lbs
 Glissières pour tiroir - 100 lbs

2022-01-06

PROJECTIONS

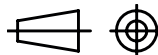

DIMENSIONS

MATERIAL/MATÉRIEL

12" x 1.80" x 1/2"

Steel zinc plated /

Acier plaqué zinc