

TECHNICAL DRAWING / DESSIN TECHNIQUE

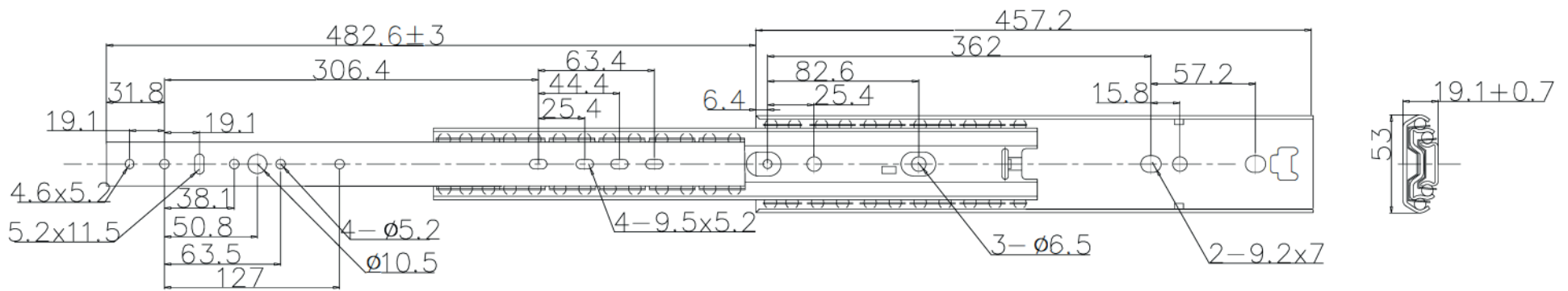

JIMEXS
HARDWARE

1 866 447-5656 / INFO@JIMEXS.COM

WWW.JIMEXS-HARDWARE.COM

323-318

Drawer Slides - 250 lbs series
 Glissières à tiroir - Serie 250 lbs

2022-04-08

PROJECTIONS

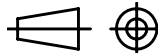

DIMENSIONS

MATERIAL/MATÉRIEL

SPECIFICATIONS/SPÉCIFICATIONS

18" x 2.09" x 3/4"

Steel zinc plated / Acier plaqué zinc

Can be use with M5 or M6 cross recessed
 pan head /

Peut être utilisée avec des vis M5 ou M6
 cruciforme à tête cylindrique large