

TECHNICAL DRAWING / DESSIN TECHNIQUE

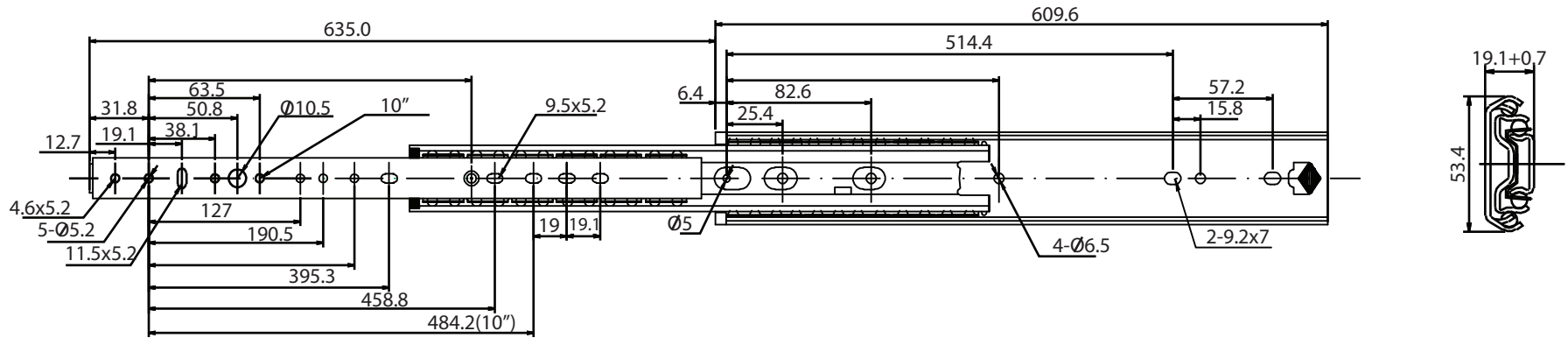

JIMEXS
HARDWARE

1 866 447-5656 / INFO@JIMEXS.COM
 WWW.JIMEXS-HARDWARE.COM

323-324

Drawer Slides - Cap. 250 lbs
 Glissières pour tiroir - 250 lbs

2021-09-22

PROJECTIONS



DIMENSIONS

MATERIAL/MATÉRIEL

SPECIFICATIONS/SPÉCIFICATIONS

24" x 2.09" x 3/4"

Steel zinc plated / Acier plaqué zinc

Can be use with M5 or M6 cross recessed
 pan head /

Peut être utilisée avec des vis M5 ou M6
 cruciforme à tête cylindrique large