

# TECHNICAL DRAWING / DESSIN TECHNIQUE

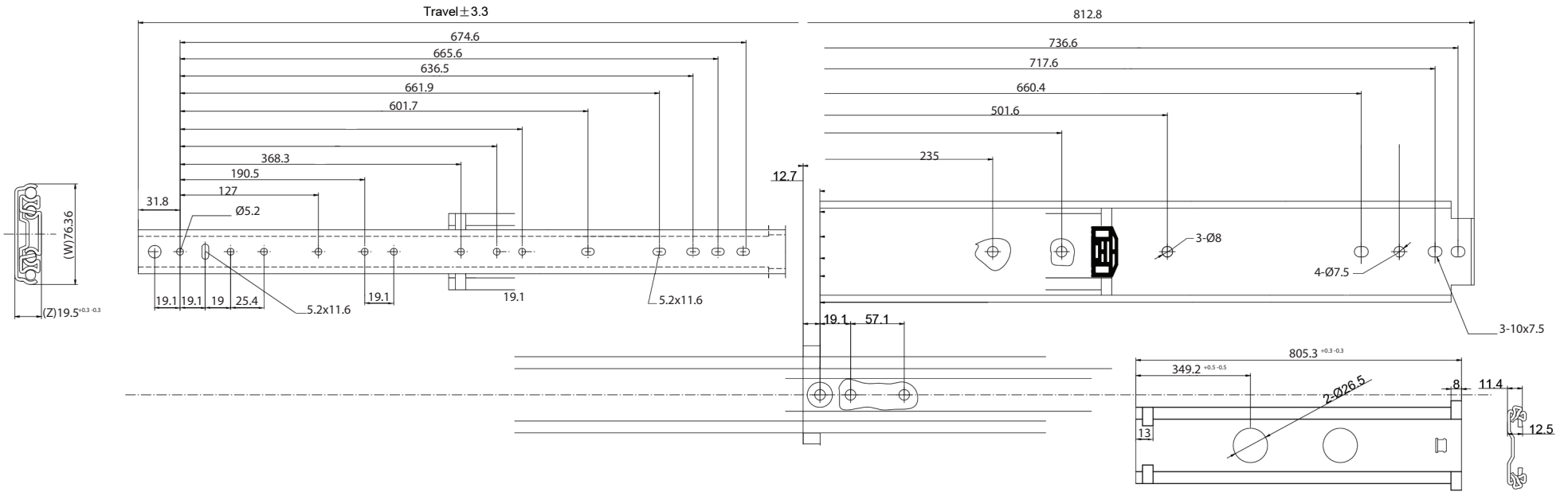

**JIMEXS**  
**HARDWARE**

1 866 447-5656 / INFO@JIMEXS.COM

WWW.JIMEXS-HARDWARE.COM

323-532

Drawer Slides - 500 lbs series  
 Glissières à tiroir - Serie 500 lbs

2021-07-05

PROJECTIONS

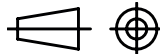

DIMENSIONS

MATERIAL/MATÉRIEL

SPECIFICATIONS/SPÉCIFICATIONS

32" x 3" x 3/4"

Steel zinc plated / Acier plaqué zinc

Can be use with M5 or M6 cross recessed  
 pan head /

Peut être utilisée avec des vis M5 ou M6  
 cruciforme à tête cylindrique large