

TECHNICAL DRAWING / DESSIN TECHNIQUE

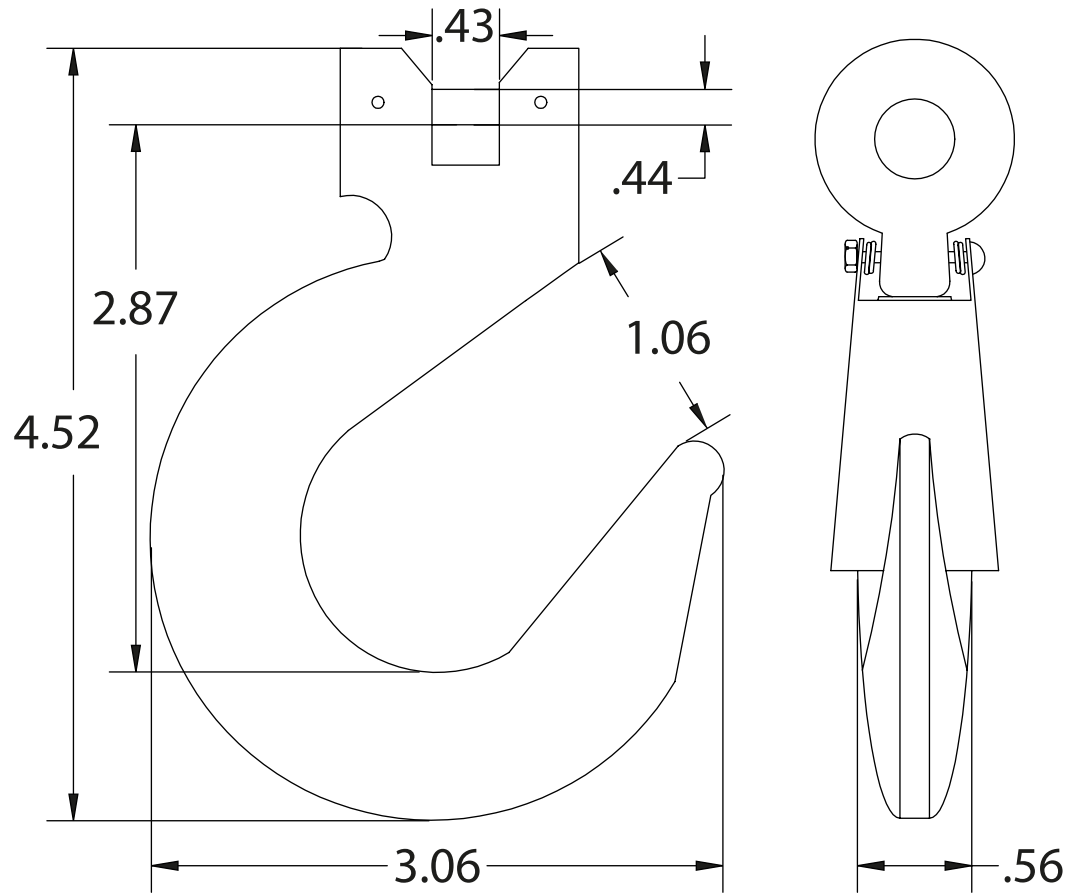

JIMEXS
HARDWARE

1 866 447-5656 / INFO@JIMEXS.COM

WWW.JIMEXS-HARDWARE.COM

413-213

Crochet coulissant à manille G70
 Clevis slip hook G70

2022-01-28

PROJECTIONS



DIMENSIONS

MATERIAL / MATÉRIEL

SPECS

5/16"

Acier forgé plaqué zinc or /

Gold zinc plated forged steel

WLL: 4290 lb, BS: 12870 lb