

TECHNICAL DRAWING / DESSIN TECHNIQUE

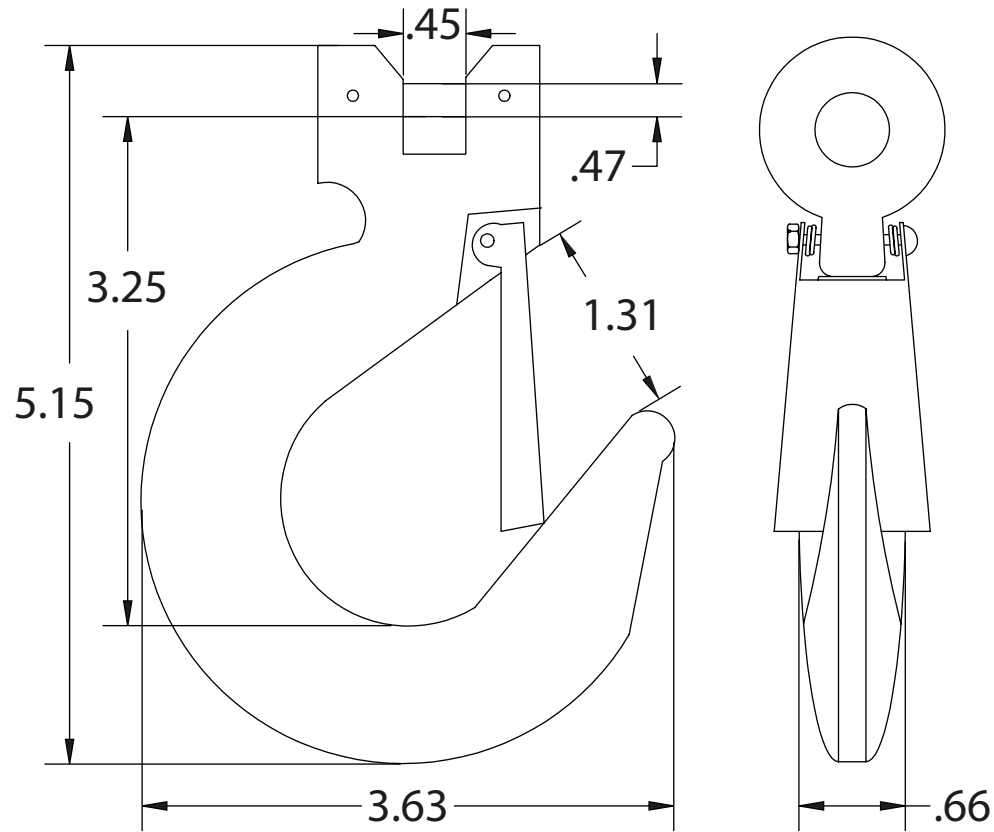

JIMEXS
HARDWARE

1 866 447-5656 / INFO@JIMEXS.COM

WWW.JIMEXS-HARDWARE.COM

413-225

Crochet coulissant à manille
 avec loquet G70
 Clevis slip hook with latch G70

2022-01-28

PROJECTIONS



DIMENSIONS

3/8"

MATERIAL / MATÉRIEL

Acier forgé plaqué zinc or /
 Gold zinc plated forged steel

SPECS

WLL: 5230 lb, BS: 15690 lb